

# K4500 /4550 series Installation Dimensions & Tech Data

## Length calculation

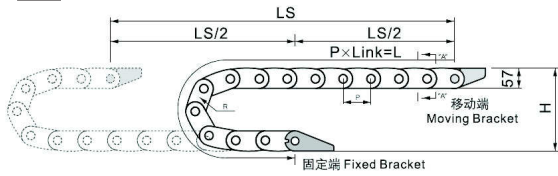

$$L = \frac{LS}{2} + \pi \times R + 268$$

L: Length  
R: bending Radius  
H: Installation Height  
P: Pitch  
268: Safety Length

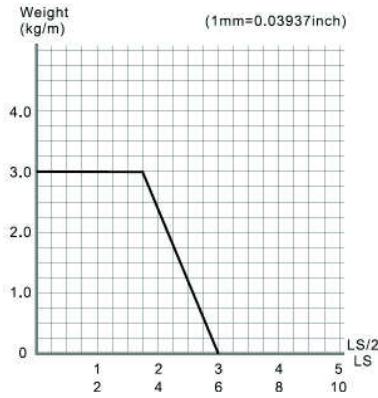

K4500 series can be open by both side

Type	Inner width (mm)	Outer width (mm)	Bending radius(mm)	Pitch (mm)	Weight (kg)
4500.050.□.0	50	75	100 125 150 200	67	2.40
4500.075.□.0	75	100	100 125 150 200	67	2.60
4500.100.□.0	100	125	100 125 150 200	67	2.90
4500.125.□.0	125	150	100 125 150 200	67	3.30
4500.150.□.0	150	175	100 125 150 200	67	3.55
4500.175.□.0	175	200	100 125 150 200	67	3.70
4500.200.□.0	200	225	100 125 150 200	67	3.90
4500.250.□.0	250	275	100 125 150 200	67	4.00

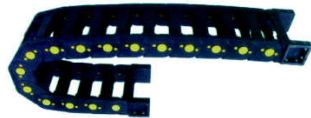
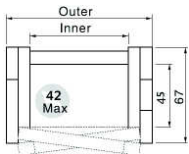

K4550 series can be open by both side

Type	Inner width (mm)	Outer width (mm)	Bending radius(mm)	Pitch (mm)	Weight (kg)
4550.075.□.0	75	100	100 125 150 200	67	2.80
4550.100.□.0	100	125	100 125 150 200	67	3.20
4550.125.□.0	125	150	100 125 150 200	67	3.40

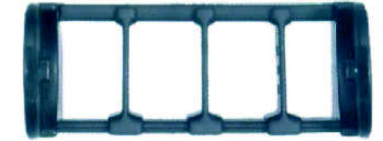
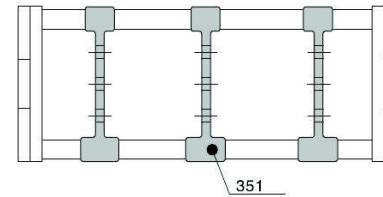
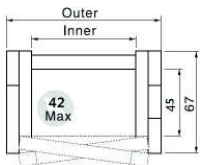

## Fixed bracket

## Moving bracket

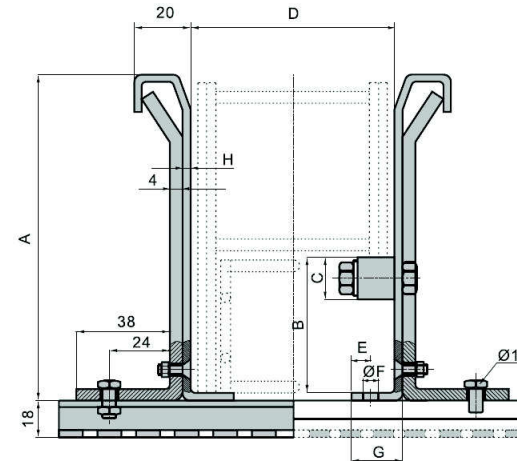
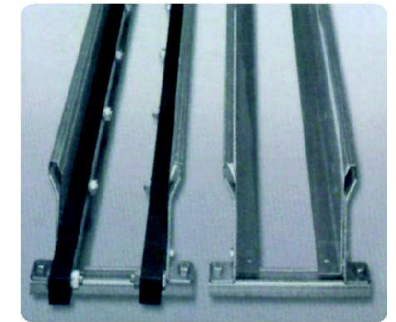
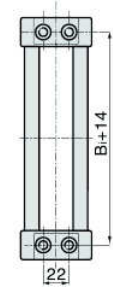
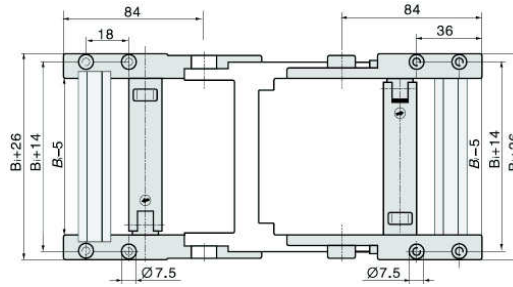

Cable tray without slide strip	3
Cable tray with slide strip	3
A	130
B	64
C	30
D	*
E	15
F	9
G	35
H	2